

REDNET MP8R

MIC PRE

User Guide

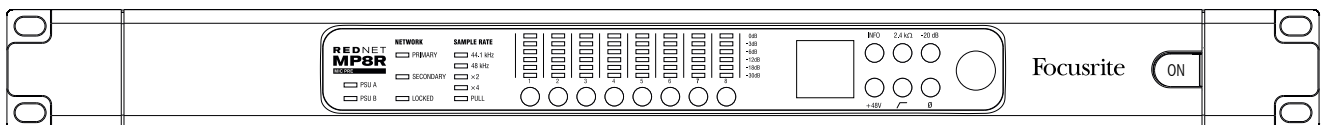

Focusrite®

www.focusrite.com

IMPORTANT SAFETY INSTRUCTIONS

1. Read these instructions.
2. Keep these instructions.
3. Heed all warnings.
4. Follow all instructions.
5. Do not use this apparatus near water.
6. Clean only with dry cloth.
7. Do not block any ventilation openings. Install in accordance with the manufacturer's instructions.
8. Do not install near any heat sources such as radiators, heat registers, stoves, or other apparatus (including amplifiers) that produce heat.
9. Do not defeat the safety purpose of the polarized or grounding-type plug. A polarized plug has two blades with one wider than the other. A grounding type plug has two blades and a third grounding prong. The wide blade or the third prong are provided for your safety. If the provided plug does not fit into your outlet, consult an electrician for replacement of the obsolete outlet.
10. Protect the power cord from being walked on or pinched particularly at plugs, convenience receptacles, and the point where they exit from the apparatus.
11. Only use attachments/accessories specified by the manufacturer.
12.  Use only with the cart, stand, tripod, bracket, or table specified by the manufacturer, or sold with the apparatus. When a cart is used, use caution when moving the cart/apparatus combination to avoid injury from tip-over.
13. Unplug this apparatus during lightning storms or when unused for long periods of time.
14. Refer all servicing to qualified service personnel. Servicing is required when the apparatus has been damaged in any way, such as power-supply cord or plug is damaged, liquid has been spilled or objects have fallen into the apparatus, the apparatus has been exposed to rain or moisture, does not operate normally, or has been dropped.

No naked flames, such as lighted candles, should be placed on the apparatus.

The appliance coupler is used as the disconnect device, the disconnect device shall remain readily operable.

Do not use a damaged or frayed power cord.

If the mains plug supplying the apparatus incorporates a fuse then it should only be replaced with a fuse of identical or lower rupture value.

GB The apparatus shall be connected to a mains socket outlet with a protective earthing connection.

FIN Laitte on liitettävä suojamaadoituskoskettimilla ja rustettuumpistorasiaan

NOR Apparatet må tikoples jordet stikkontakt

SWE Apparatens skall anslutas till jordat uttag



CAUTION
RISK OF ELECTRIC SHOCK
DO NOT OPEN



CAUTION: TO REDUCE THE RISK OF ELECTRIC SHOCK, DO NOT REMOVE COVER (OR BACK). NO USER-SERVICEABLE PARTS INSIDE. REFER SERVICING TO QUALIFIED SERVICE PERSONNEL.



The lightning flash with arrowhead symbol, within equilateral triangle, is intended to alert the user to the presence of uninsulated "dangerous voltage" within the product's enclosure that may be of sufficient magnitude to constitute a risk of electric shock to persons.



The exclamation point within an equilateral triangle is intended to alert the user to the presence of important operating and maintenance (servicing) instructions in the literature accompanying the appliance.

WARNING: TO REDUCE THE RISK OF FIRE OR ELECTRIC SHOCK, DO NOT EXPOSE THIS APPARATUS TO RAIN OR MOISTURE AND OBJECTS FILLED WITH LIQUIDS, SUCH AS VASES, SHOULD NOT BE PLACED ON THIS APPARATUS.

ENVIRONMENTAL DECLARATION

Compliance Information Statement: Declaration of Compliance procedure

Product Identification: Focusrite RedNet
Responsible party: American Music and Sound
Address: 4325 Executive Drive
Suite 300
Southaven
MS 38672
Telephone: 800-431-2609

This device complies with part 15 of the FCC Rules. Operation is subject to the following two conditions: (1) This device may not cause harmful interference, and (2) this device must accept any interference received, including interference that may cause undesired operation.

For USA

To the User:

- 1. Do not modify this unit!** This product, when installed as indicated in the instructions contained in this manual, meets FCC requirements. Modifications not expressly approved by Focusrite may void your authority, granted by the FCC, to use this product.
- 2. Important:** This product satisfies FCC regulations when high quality shielded cables are used to connect with other equipment. Failure to use high quality shielded cables or to follow the installation instructions within this manual may cause magnetic interference with appliances such as radios and televisions and void your FCC authorization to use this product in the USA.
- 3. Note:** This equipment has been tested and found to comply with the limits for a Class A digital device, pursuant to part 15 of the FCC Rules. These limits are designed to provide reasonable protection against harmful interference in a commercial environment. This equipment generates, uses and can radiate radio frequency energy and, if not installed and used in accordance with the instructions, may cause harmful interference to radio communications. Operation of this equipment in a residential area is likely to cause harmful interference in which the user will be required to correct the interference at his own expense

For Canada

To the User:

This Class A digital apparatus complies with Canadian ICES-003.

Cet appareil numérique de la classe A est conforme à la norme NMB-003 du Canada.

RoHS Notice

Focusrite Audio Engineering Limited has conformed where applicable, to the European Union's Directive 2002/95/EC on Restrictions of Hazardous Substances (RoHS) as well as the following sections of California law which refer to RoHS, namely sections 25214.10, 25214.10.2, and 58012, Health and Safety Code; Section 42475.2, Public Resources Code.

CONTENTS

IMPORTANT SAFETY INSTRUCTIONS	2
About this User Guide	5
Box Contents	5
INTRODUCTION	6
Gain Compensated Split Outputs	7
Headroom Allowance	7
INSTALLATION GUIDE	8
RedNet MP8R Connections and Features	8
Front Panel	8
Rear Panel	10
Power Connection	11
IEC Power Cord Retaining Clips	11
Physical Characteristics	12
Power Requirements	12
REDNET MP8R OPERATION	13
First Use and Firmware Updates	13
Digital Clocking	13
Pull Up and Pull Down Operation	13
Front Panel Control Lockout	13
Gain Compensated Outputs	13
OTHER REDNET SYSTEM COMPONENTS	14
USING REDNET CONTROL	14
ID (Identification)	15
Tools Menu	15
APPENDIX	16
Connector Pinouts	16
Ethernet Connector	16
XLR Connectors	16
PERFORMANCE AND SPECIFICATIONS	17
Focusrite RedNet Warranty and Service	19
Registering Your Product	19
Customer Support and Unit Servicing	19
Troubleshooting	19

About this User Guide

This User Guide applies only to the RedNet MP8R Mic Preamplifier. It provides information about installing a RedNet MP8R and how to connect it into your system.

A RedNet System User Guide is also available from the RedNet product pages of the Focusrite website. The Guide provides a detailed explanation of the RedNet system concept, that will help you achieve a thorough understanding of its capabilities. We recommend that all users, including those already experienced in digital audio networking, take the time to read through the System User Guide so that they are fully aware of all the possibilities that RedNet and its software have to offer.

Should either User Guide not provide the information you need, be sure to consult:

www.focusrite.com/rednet, which contains a comprehensive collection of common technical support queries.

Box Contents

- RedNet MP8R unit
- 2 x IEC AC mains cables
- 2 x IEC mains cable retaining clips (*See instructions on page 11*)
- Safety information cut sheet
- RedNet Getting Started Guide
- Product registration card, provides links to:
 - RedNet Control
 - RedNet PCIe drivers (included with RedNet Control download)
 - Audinate Dante Controller (installed with RedNet Control)
 - Dante Virtual Soundcard (DVS) Token and download instructions

INTRODUCTION

Thank you for purchasing the Focusrite RedNet MP8R.



RedNet MP8R is an 8-channel remote-controlled microphone preamplifier and A/D for the Dante audio-over-IP network. Specifically tailored for the road, live-sound and broadcast environments, each unit features network and power redundancy, rugged construction with latching connectors, remote control and remote monitoring. In addition, a gain-compensated split output is available on every channel (*see following page for further detail*).

Eight remote-controlled Focusrite mic preamps and precision A/D conversion at up to 192kHz/24-bit with minimum latency.

Dual Ethernet connectors (primary and secondary) on the rear-panel allow maximum network reliability with seamless switchover to a standby network in the unlikely event of a network failure. These ports may also be used to daisy-chain additional units when operating in Switched mode.

Redundant power supplies (PSU A and B) with separate input sockets on the rear panel allow one supply to be connected to an uninterruptible source. Each PSU's status can be monitored remotely over the network or from the front panel.

Audio input uses locking XLR3F connectors on the rear panel.

Rotary gain control with OLED level display for indication of gain settings and system information. A Select button plus 6-segment level meter is provided for each channel. Individual buttons for the selection of input impedance, 20dB Pad, 48V phantom power, high-pass filter and polarity inversion are included on the front panel.

Channels can be remotely controlled via the RedNet Control software package, Pro Tools and MIDI, or OCA (Open Control Architecture) with future firmware updates.

The RedNet MP8R front panel contains a set of LEDs to confirm network status, sample rate and clock sources as well as each mic amp's input and gain settings.

Gain Compensated Split Outputs

The RedNet MP8R is able to provide two outputs from each mic channel: one direct and a second automatically gain-compensated to deliver a constant level. This arrangement allows one engineer (FOH, say) to control the analogue mic gain without affecting the signal level being received by a second engineer on the network.

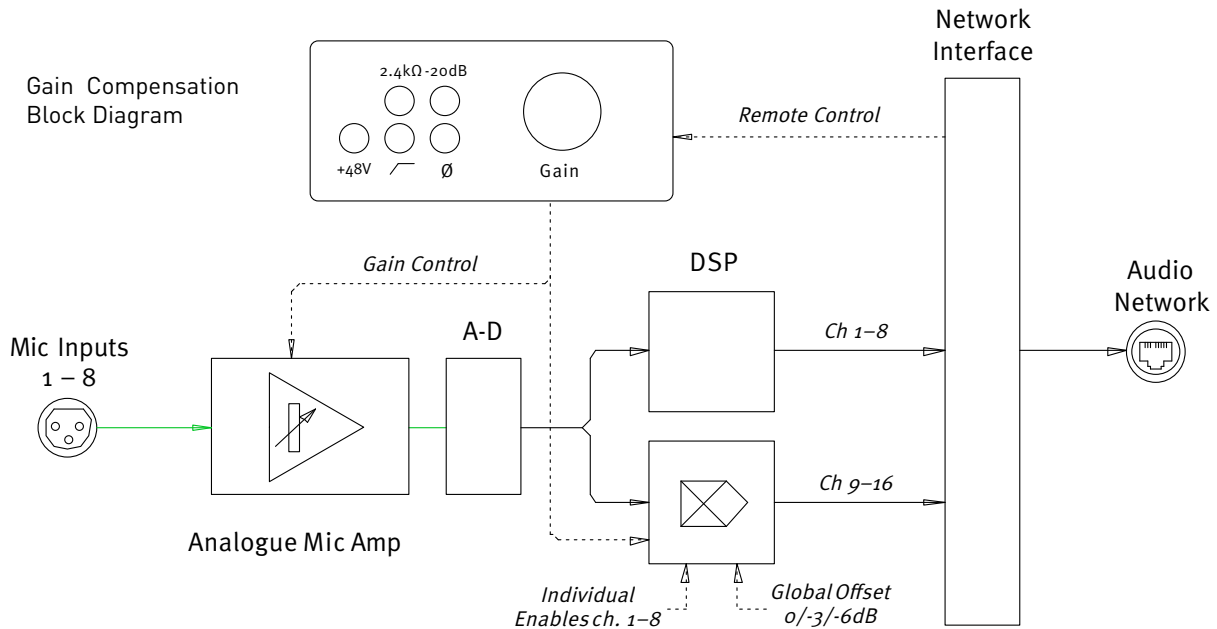

The output of the mic amp module feeds the A-D converter. Once in the digital domain, the signal is split into two streams. The first stream passes through unaffected to the corresponding Dante transmitter. The second stream passes through a DSP amplifier which automatically compensates for any changes made to the analogue audio level – either by the front panel controls or over the network. The unit will therefore appear as a 16-channel device on the Dante network, with channels 1-8 being the direct outputs from the preamps and channels 9-16 the compensated outputs.

Gain compensation can be enabled individually for each mic channel.

Headroom Allowance

If during a performance an analogue mic level was reduced by 3dB, the DSP gain for the corresponding 'split' channel would be increased by 3dB to maintain its overall signal level[†]. Note however, that this action would push the DSP section 3dB closer to its clipping point. To minimise the likelihood of the DSP ever reaching its clipping point an offset can be applied to allow for some reserve headroom.

The default headroom offset setting will be -6dB, but the user can select 0dB or -3dB from the tools menu under RedNet Control. The setting is applied to all channels 9-16.

[†]The global range of the gain compensation available is currently limited to tracking ± 12 dB from the point at which it was enabled.

INSTALLATION GUIDE

RedNet MP8R Connections and Features

Front Panel

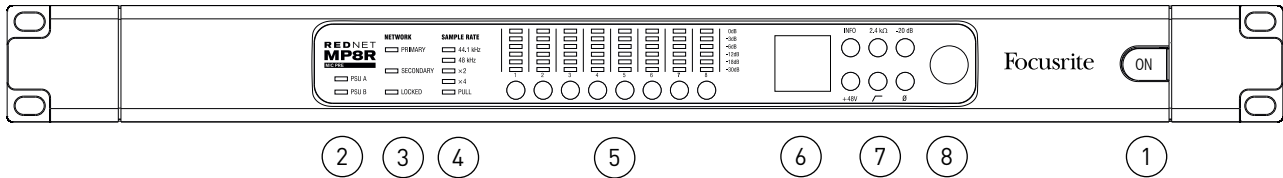

1. AC Power Switch

2. Power Indicators:

- **PSU A** – Illuminates when an AC input is applied and all DC outputs are present.
- **PSU B** – Illuminates when an AC input is applied and all DC outputs are present.

When both supplies are functioning and have AC inputs PSU A will be the default supply.

3. RedNet Network Status Indicators:

- **PRIMARY** – Illuminates when the device is connected to an active Ethernet network. Also illuminates to indicate network activity when operating in switched mode.
- **SECONDARY** – Illuminates when the device is connected to an active Ethernet network. Not used when operating in Switched mode.
- **LOCKED** – Illuminates when a valid sync signal is received from the network, or when the RedNet MP8R unit is Network Master.

4. RedNet Sample Rate Indicators

Five orange indicators: **44.1 kHz**, **48 kHz**, **x2** (multiple of 44.1 or 48), **x4** (multiple of 44.1 or 48) and sample rate **PULL UP/DOWN**. These Indicators illuminate individually or in combination to indicate the sample rate being used. For example: for a 96kHz Pull Up/Down setting, the 48kHz, x2 and Pull Up/Down indicators will illuminate.

5. Channel Select Switches and Signal Level LEDs

A Select switch plus six signal-level LEDs for each of the eight channels. Pressing a switch selects which channel is to be controlled – the OLED display will then indicate the current gain setting of that channel. Signal level LEDs illuminate at: -30dB, -18dB, -12dB (green), -6dB, -3dB (orange) and 0dB/onset of clipping (red).

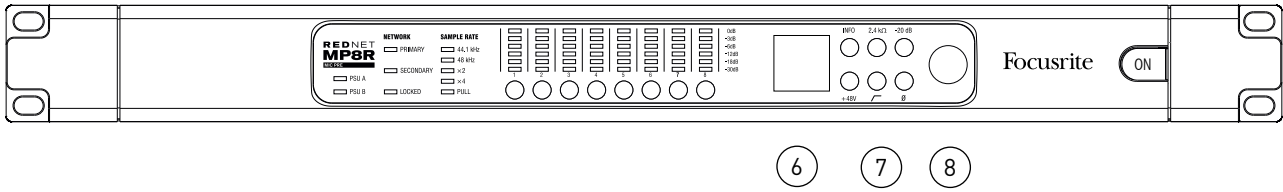

The Select switches can also be used to activate front panel control lockout; see page 13.

Front Panel ... Continued

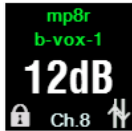

6. OLED Display



Indicates the currently selected channel's network name and its gain value and if either Control Lockout  or Gain Compensation  is active. Also changes to display local and network configuration settings when in INFO mode. *See below.*

7. Local Control Buttons:

- **INFO** – Press to show device and network information on the OLED display [button will flash orange when Info mode is engaged]. Pressing again cycles through following unit settings:

- Unit IP addresses (primary)
- Unit IP addresses (secondary)
- Unit MAC addresses (primary)
- Unit MAC addresses (secondary)
- Firmware Version for the unit
- Device name

PRIMARY IP 169. 254. 17. 55.	SECONDARY MAC 00:1D:C1 02:02:5D
VERSION 903/871 3.7.1.6 3.1.5	UNIT NAME MP8R Stage-Left

- **+48V** – Switches phantom power on for selected channel.
- **2.4 kΩ** – Selects low input impedance for selected channel.
-  – Switches on high-pass filter for selected channel.
- **-20 dB** – Switches input pad in for selected channel.
- **∅** – Inverts polarity of signal on selected channel.

8. Encoder

The detented encoder is used as the gain control for the selected mic channel.

Note: When renaming a device, the name will appear on a single line on the OLED display. To separate the name over two lines like the OLED example above, add in a double-dash '--'. In the example above, this would be written as 'mp8r--b-vox-1'.

Rear Panel

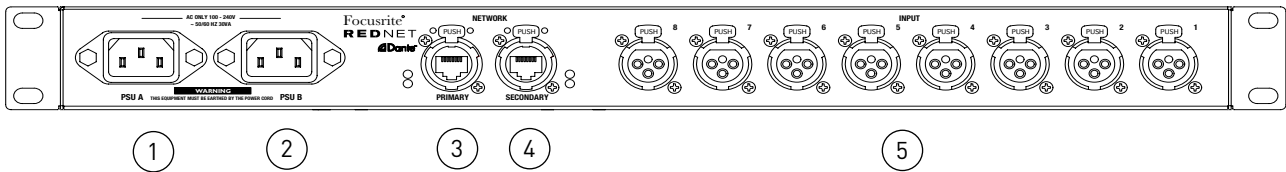

1. IEC Mains Inlet A

Standard IEC receptacle for connection of AC mains. RedNet MP8R features 'Universal' PSUs, enabling it to operate on any supply voltage of between 100 V and 240 V AC.

Note that initial use requires fitment of the plug retaining clips – see page 11.

2. IEC Mains Inlet B

Input connector for backup mains power source. Power supply B remains on standby but will seamlessly take over if PSU A develops a fault or loses its mains input supply.

If an uninterruptible supply (UPS) is available, it is recommended that this is applied to input B.

3. Primary Network Port

Latching etherCON connector for the Dante network. Use standard Cat 5e or Cat 6 network cable to connect to a local Ethernet switch to connect the RedNet MP8R to the RedNet network. Adjacent to each network socket are LEDs which illuminate to indicate a valid network connection plus network activity. *See page 16 for connector details.*

4. Secondary Network Port

Secondary Dante network connection where two independent Ethernet links are being used (Redundant mode) or an additional port on an integral network switch on the primary network (Switched mode).

5. Microphone inputs

Eight latching XLR3F connectors for mic/line input.

See page 16 for connector pinouts.

Power Connection

IEC Power Cord Retaining Clips

RedNet MP8R is supplied with two IEC power cord retaining clips. These prevent accidental disconnection of a power cord during use. When the unit is first installed, the retaining clips will need to be attached to the power input sockets on the rear panel.

Insert each clip by squeezing together the legs as shown in the first image below, aligning the pins with the through-holes on the IEC fixing posts one at a time, and then releasing.

Ensure that the orientation of each clip is as shown in the other images below or its effectiveness will be compromised.

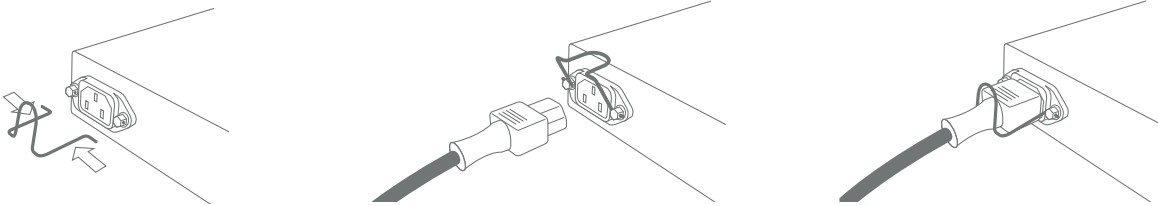

Physical Characteristics

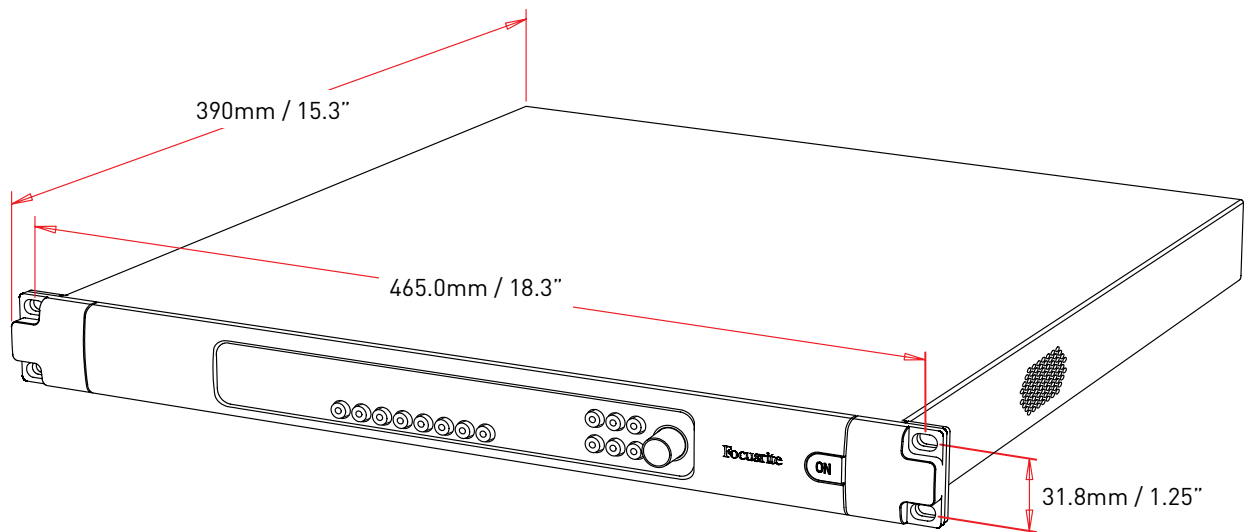

RedNet MP8R dimensions are illustrated in the diagram above.

RedNet MP8R requires 1U of vertical rack space and at least 440mm of rack depth, to allow for cables. RedNet MP8R weighs 5.75 kg and for installations in a fixed environment (eg., a studio), the front-panel mounting screws will provide adequate support. If the units are to be used in a mobile situation (eg., flight-cased for touring, etc.), it is recommended that side support rails or shelves should be used within the rack.

Cooling is by low-noise fan assistance from side to side. The fan used is low-speed and low-noise but can also be turned off via RedNet control.

Do not mount RedNet MP8R immediately above any other equipment which generates significant heat, for example, a power amplifier. Also, ensure that when mounted in a rack, the side vents are not obstructed.

Power Requirements

RedNet MP8R is mains-powered. It incorporates 'Universal' power supplies, which can operate on any AC mains voltage from 100 V to 240 V. The AC connections are made via a standard 3-pin IEC connectors on the rear panel.

When PSU A & PSU B are both connected, PSU A becomes the default supply and therefore draws more current than B. If a backup mains supply is provided from an uninterruptible source, it is recommended that this is connected to input B.

Mating IEC cables are supplied with the unit; these should be terminated with mains plugs of the correct type for your country.

The AC power consumption of the RedNet MP8R is 30VA.

Please note that there are no fuses in RedNet MP8R, or other user-replaceable components of any type. Please refer all servicing issues to the Customer Support Team (see "Customer Support and Unit Servicing" on page 19).

REDNET MP8R OPERATION

First Use and Firmware Updates

Your RedNet MP8R may require a firmware update* when it is first installed and switched on. Firmware updates are initiated and handled automatically by the RedNet Control application.

**It is important that the firmware update procedure is not interrupted – either by switching off power to the RedNet MP8R or the computer on which RedNet Control is running, or by disconnecting either from the network.*

From time to time Focusrite will release RedNet firmware updates within new versions of RedNet Control. We recommend keeping all RedNet units up to date with the latest firmware version supplied with each new version of RedNet Control.

Digital Clocking

Each MP8R will automatically lock to a valid Network Master via its Dante connection. Alternatively, if a Network Master is not present, then the unit can be chosen as the Network Master by the user.

Pull Up and Pull Down Operation

RedNet MP8R is able to operate at a specified pull up or pull down percentage as selected in the Dante Controller application.

Front Panel Control Lockout

To prevent accidental adjustment of any control that could affect a channel's audio level, the MP8R front panel can be locked-out. When locked, the gain encoder and the channel function switches become inactive for all eight channels. Channel settings can still be viewed on the OLED display by pressing the channel Select buttons and the INFO button will still operate as normal.

- To activate lockout: Press channel Select buttons 1, 3, 5 & 7 simultaneously.
- To de-activate lockout: Press channel Select buttons 2, 4, 6 & 8 simultaneously.

The Lock icon  illuminates on the OLED display when lockout is active. Lockout can also be activated and de-activated from the Tools menu under RedNet Control.

Gain Compensated Outputs

To turn on gain compensation in the corresponding 'split' output for any channel, press and hold the channel Select button until the Gain Compensation icon  illuminates on the OLED display. To turn off, press and hold Select again until the Lock icon is no longer visible.

Gain Compensation can also be activated and de-activated for each channel from the device graphic on RedNet Control.

OTHER REDNET SYSTEM COMPONENTS









The RedNet hardware range includes various types of I/O interface and a PCIe digital audio interface card which is installed in the system's host computer. All the I/O units can be considered as "Break-Out" (and/or "Break-In") boxes to/from the network, and all are built in mains-powered, 19" rackmount housings. There are also three software items, RedNet Control (see below), Dante Controller and Dante Virtual Soundcard.

USING REDNET CONTROL

RedNet Control will reflect the status of the RedNet units present in the system, presenting an image representing each hardware unit.



The illustration above shows the RedNet MP8R RedNet Control image. The signal level, gain and input function settings are indicated for each channel.

-   PSUs A & B – Each illuminates if PSU has power input and all DC outputs are present.
-   Networks – Each illuminates if a valid connection is present.
-   Locked – Unit is successfully locked to the network (changes to the red cross if not locked).
-   Network Master – Illuminated indicating that unit is the network master.

Device View

- Pad** – Switches in the -20dB input pad for the selected channel
- 2.4kΩ** – Selects low input impedance for the selected channel
- +48V** – Switches the phantom power on for the selected channel
- Ø** – Reverses the phase of the selected channel
-  – Switches in the high-pass filter for the selected channel
- Gain Compensation** – Turns on gain compensation. While engaged, on-board DSP will counteract analogue gain changes for the second set of network outputs (Channels 9-16)

ID (Identification)

Clicking on the ID icon  will identify the physical device being controlled by flashing its front panel LEDs.

Tools Menu

Clicking on the Tools icon  will gain access to the following system settings:

Front Panel Lockout – On or Off. Disables front panel audio controls.

Cooling Fan – On or Off. For use when unit is located in silent recording areas.

Preferred Master – On/Off state.

MIDI Channel Select – Set the MIDI channel (1 – 16) to which the unit will respond:

- Off
- MIDI Channel 1
- MIDI Channel 2
- ↓
- MIDI Channel 16

Notes:

- The default is "Off"
- 16 channels are available, allowing a maximum of 16 independent RedNet MP8R control paths
- Two devices should not be set to the same MIDI channel
- MIDI channel selection is saved with the computer, not the device. Therefore, when controlling the same unit from a different computer, the MIDI channel allocation may no longer be the same

For more information, please download the MIDI Control User Guide from www.focusrite.com

Yamaha ID Select – Set the Yamaha ID (Y000 – Y00F) to which the unit will respond:

- Off
- Y000
- Y001
- ↓
- Y00F

For more information, please refer to the Yamaha Control user guide, available at www.focusrite.com

Gain Compensation – Offset value for network channels 9– 16. Only one can be selected at any time.

- 0dB
- -3dB
- -6dB

APPENDIX

Connector Pinouts

Ethernet Connector

Connector type: RJ-45 receptacle
Applies to: Ethernet (Dante)

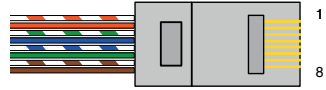

Pin	Cat 6 Core
1	White + Orange
2	Orange
3	White + Green
4	Blue
5	White + Blue
6	Green
7	White + Brown
8	Brown

XLR Connectors

Connector type: XLR-3 receptacle
Applies to: Audio Input

Pin	Signal
1	Screen
2	Hot (+ve)
3	Cold (-ve)

PERFORMANCE AND SPECIFICATIONS

Microphone Inputs	
Gain Range	10dB to 65dB in 1dB steps
Type	Electronically Balanced, $Z_{in} = 2.4k\Omega/10k\Omega$ (Switchable); Inputs default to 2.4k Ω when unit is unpowered
Maximum Input Level	29dBu ± 0.5 ; min gain with pad for 0dBFS, $R_s = 150\Omega$
Minimum Input Level	-46dBu ± 0.5 ; max gain without pad for 0dBFS, $R_s = 150\Omega$
Frequency Response	20Hz – 40kHz ± 0.1 dB
THD + N	-98dB (0.0012%) @ -1dBFS, $R_s = 150\Omega$
EIN	-129 dBu 'A'-Weighted (typical), $R_s = 150\Omega$
Signal-to-Noise Ratio	118 dB 'A'-Weighted (typical), $R_s = 150\Omega$
Phantom Power	+48V, independently switchable per channel
Pad	-20dB, independently switchable per channel
High-Pass Filter	-6dB @ 65Hz ± 3 Hz, 12dB/Octave, independently switchable per channel

Crosstalk	
Input to Input	<-100dB 20Hz-20KHz; minimum input gain

Digital Performance	
Supported Sample Rates	44.1 / 48 / 88.2 / 96 / 176.4 / 192 kHz [-4% / -0.1% / +0.1% / +4.167%] at 24 bit
Clock Sources	Internal or from Dante Network Master

Rear Panel Connectivity	
Inputs	
Inputs	8 x female XLR-3
PSU & Network	
PSU	2 x IEC male inputs with retaining clips
Network	2 x etherCON connectors, also compatible with standard RJ45 connectors

Indicators	
Primary PSU (A)	Green LED. Illuminates when an AC input is applied and all DC outputs are present.
Secondary PSU (B)	Green LED. Illuminates when an AC input is applied and all DC outputs are present.
Primary Network	Green LED. Indicates that a network connection is present on primary port when in redundant mode. When in Switched mode, a valid network connection at either Primary or Secondary network port will cause this LED to illuminate.
Secondary Network	Green LED. Indicates that a network connection is present on secondary port when in redundant mode. Not used in switched mode.
Network Locked	Green LED. When unit is network slave, shows valid network lock. When unit is network master, shows lock to internal clock.
Sample Rate	Orange LED for each: 44.1 kHz, 48 kHz, x2, x4
Pull Up/Down	Orange LED. Indicates unit is set to operate on a Dante pull up/down domain.
Channel Signal level	6 level indicator LEDs for each channel. 3 green LEDs, (-30dB, -18dB, -12dB); 2 orange LEDs (-6dB, -3dB); red LED (0dB/onset of clipping).
Channel Select Buttons	8
Channel Function Controls	Info, Phantom Power, Pad, Impedance, HPF, Phase, Gain Encoder.
Channel Display	Colour OLED. Displays Channel Name, Gain, Lock status (when on), Channel Number, Gain Compensation status (when on).

Network Modes	
Redundant	Allows unit to connect to two independent networks
Switched	Connects both ports to integrated network switch allowing daisy-chaining of device

Dimensions	
Height	44.5mm / 1.75" (1RU)
Width	482.6mm / 19"
Depth	394mm / 15.51"

Weight	
Weight	5.75kg

Power	
PSU	2 x Internal, 100-240V, 50/60Hz, consumption 30VA

Focusrite RedNet Warranty and Service

All Focusrite products are built to the highest standards and should provide reliable performance for many years, subject to reasonable care, use, transportation and storage.

Very many of the products returned under warranty are found not to exhibit any fault at all. To avoid unnecessary inconvenience to you in terms of returning the product please contact Focusrite support.

In the event of a Manufacturing Defect becoming evident in a product within 12 months from the date of the original purchase Focusrite will ensure that the product is repaired or replaced free of charge.

A Manufacturing Defect is defined as a defect in the performance of the product as described and published by Focusrite. A Manufacturing Defect does not include damage caused by post-purchase transportation, storage or careless handling, nor damage caused by misuse.

Whilst this warranty is provided by Focusrite the warranty obligations are fulfilled by the distributor responsible for the country in which you purchased the product.

In the event that you need to contact the distributor regarding a warranty issue, or an out-of-warranty chargeable repair, please visit: www.focusrite.com/distributors

The distributor will then advise you of the appropriate procedure for resolving the warranty issue. In every case it will be necessary to provide a copy of the original invoice or store receipt to the distributor. In the event that you are unable to provide proof of purchase directly then you should contact the reseller from whom you purchased the product and attempt to obtain proof of purchase from them.

Please do note that if you purchase a Focusrite product outside your country of residence or business you will not be entitled to ask your local Focusrite distributor to honour this limited warranty, although you may request an out-of-warranty chargeable repair.

This limited warranty is offered solely to products purchased from an Authorised Focusrite Reseller (defined as a reseller which has purchased the product directly from Focusrite Audio Engineering Limited in the UK, or one of its Authorised Distributors outside the UK). This Warranty is in addition to your statutory rights in the country of purchase.

Registering Your Product

For access to Dante Virtual Soundcard, please register your product at: www.focusrite.com/register

Customer Support and Unit Servicing

You can contact our dedicated RedNet Customer Support team free of charge:

Email: rednetsupport@focusrite.com

Phone (UK): +44 (0)1494 462246

Phone (USA): +1 (310) 322-5500

Troubleshooting

If you are experiencing problems with your RedNet MP8R, we recommend that in the first instance, you visit our Support Answerbase at: www.focusrite.com/answerbase